



Chapter 5 – Visual Aids

- **Lights (Night-time operations)**
 - Heliport Beacon
 - Approach lighting system
 - Alignment Guidance systems
 - Approach slope indicators
 - FATO lighting systems (surface-level heliport)
 - Aiming point lights
 - TLOF lighting system



Lights

General Comments & Notes

Specifications are designed to provide effective lighting systems based on night conditions. Where lights are to be used in conditions other than night (i.e. day or twilight) it may be necessary to increase the intensity of the lighting to maintain effective visual cues by use of a suitable brilliancy control.

Where brilliancy control is desired, settings of 10 per cent and 3 per cent have been found to be satisfactory. In addition, shielding may be necessary to ensure that pilots are not dazzled during the final stages of the approach and landing.

Current 3 setting intensity control systems operate at 10%, 30% and 100%.

5 setting intensity control systems operate at 0.2%, 1.0%, 5%, 25% and 100%.

Heliport Beacon

A heliport beacon should be provided at a heliport where:

- a) long-range visual guidance is considered necessary and is not provided by other visual means; or
- b) identification of the heliport is difficult due to surrounding lights.

The heliport beacon shall be located on or adjacent to the heliport preferably at an elevated position and so that it does not dazzle a pilot at short range.

Where a heliport beacon is likely to dazzle pilots at short range, it may be switched off during the final stages of the approach and landing.

The heliport beacon shall emit repeated series of equispaced short duration white flashes in the format in Figure 5-10 [0.8 sec – 1.2 sec – 0.8 sec, flash duration 0.5 -2.0 milliseconds].

The light from the beacon shall show at all angles of azimuth.

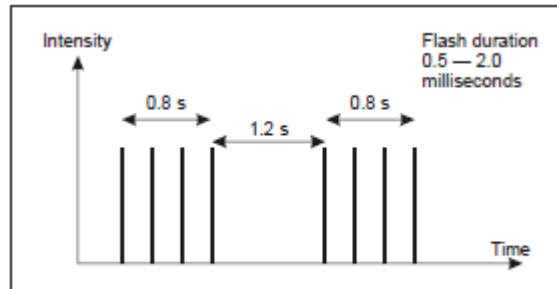

Figure 5-10. Heliport beacon flash characteristics



Approach Lighting System

Approach lighting system should be provided at a heliport where it is desirable and practicable to indicate a preferred approach direction.

The approach lighting system shall be located in a straight line along the preferred direction of approach.

Approach lighting system should consist of a row of three lights spaced uniformly at 30 m intervals and of a crossbar 18 m in length at a distance of 90 m from the perimeter of the FATO as shown in Figure 5-12. The lights forming the crossbar should be as nearly as practicable in a horizontal straight line at right angles to, and bisected by, the line of the centre line lights and spaced at 4.5 m intervals. Where there is the need to make the final approach course more conspicuous, additional lights spaced uniformly at 30 m intervals should be added beyond the crossbar. The lights beyond the crossbar may be steady or sequenced flashing, depending upon the environment.

Note.— Sequenced flashing lights may be useful where identification of the approach lighting system is difficult due to surrounding lights.

The steady lights shall be omnidirectional white lights.

Sequenced flashing lights shall be omnidirectional white lights.

The flashing lights should have a flash frequency of one per second and their light distribution should be as shown in Figure 5-11, Illustration 3.

The flash sequence should commence from the outermost light and progress towards the crossbar.

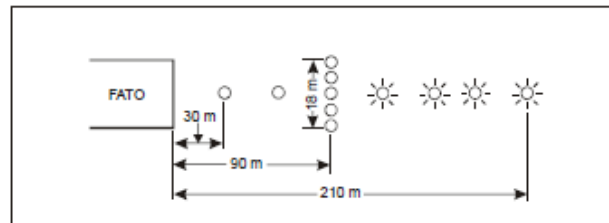
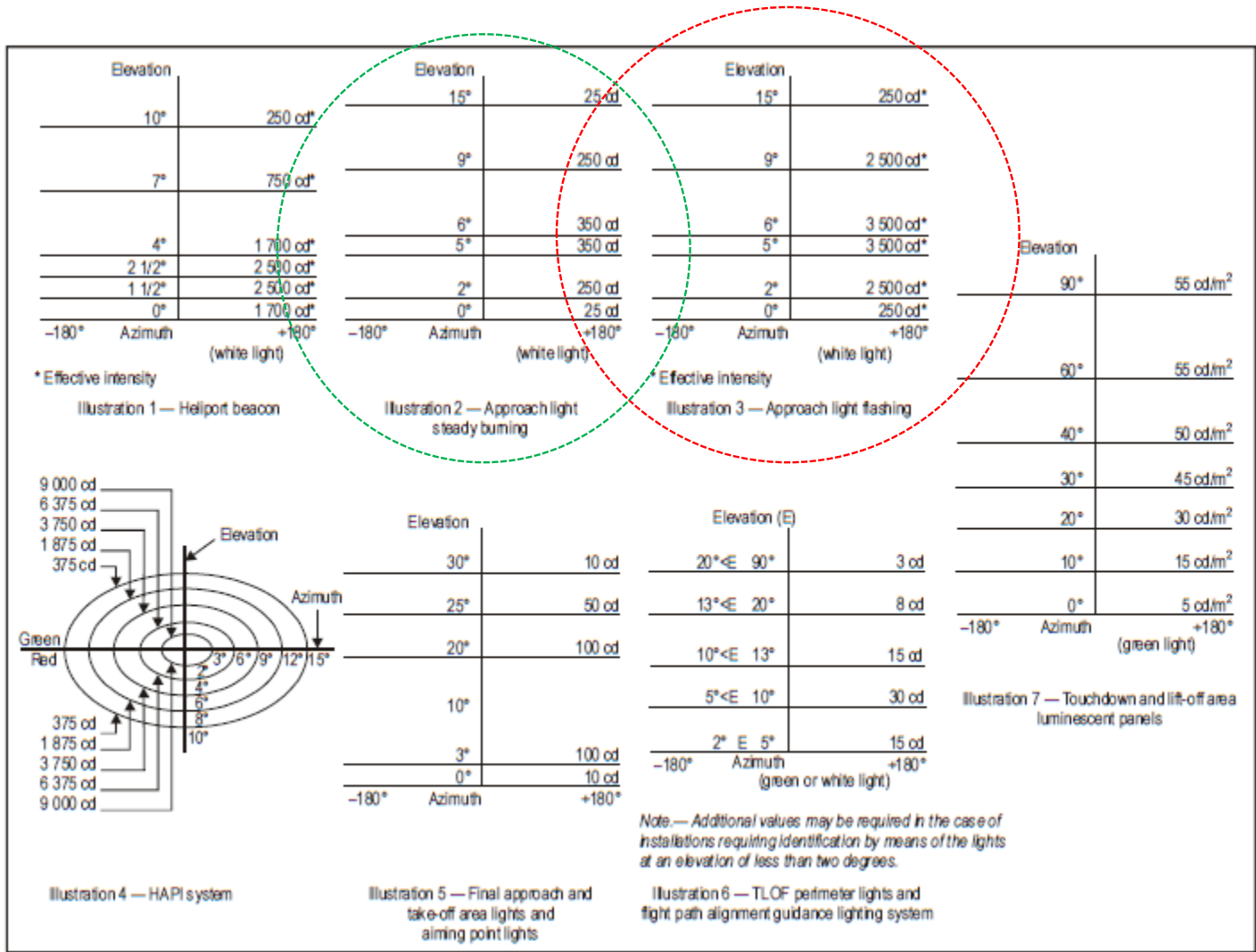

Figure 5-12. Approach lighting system

Figure 5-11. Isocandela diagrams





Flight Path Alignment Guidance Lighting System

Flight path alignment guidance lighting system(s) should be provided at a heliport where it is desirable and practicable to indicate available approach and/or departure path direction(s).

The flight path alignment guidance lighting can be combined with a flight path alignment guidance marking(s) described in 5.2.18.

The flight path alignment guidance lighting system shall be in a straight line along the direction(s) of approach and/or departure path on one or more of the TLOF, FATO, safety area or any suitable surface in the immediate vicinity of the FATO, TLOF or safety area.

If combined with a flight path alignment guidance marking, as far as is practicable the lights should be located inside the “arrow” markings.

A flight path alignment guidance lighting system should consist of a row of three or more lights spaced uniformly a total minimum distance of 6 m. Intervals between lights should not be less than 1.5 m and should not exceed 3 m. Where space permits there should be 5 lights. (See Figure 5-9.)

The number of lights and spacing between these lights may be adjusted to reflect the space available. If more than one flight path alignment system is used to indicate available approach and/or departure path direction(s), the characteristics for each system are typically kept the same. (See Figure 5-9.)

The lights shall be steady omnidirectional inset white lights.

The distribution of the lights should be as indicated in Figure 5-11, Illustration 6.

A suitable control should be incorporated to allow for adjustment of light intensity to meet the prevailing conditions and to balance the flight path alignment guidance lighting system with other heliport lights and general lighting that may be present around the heliport.

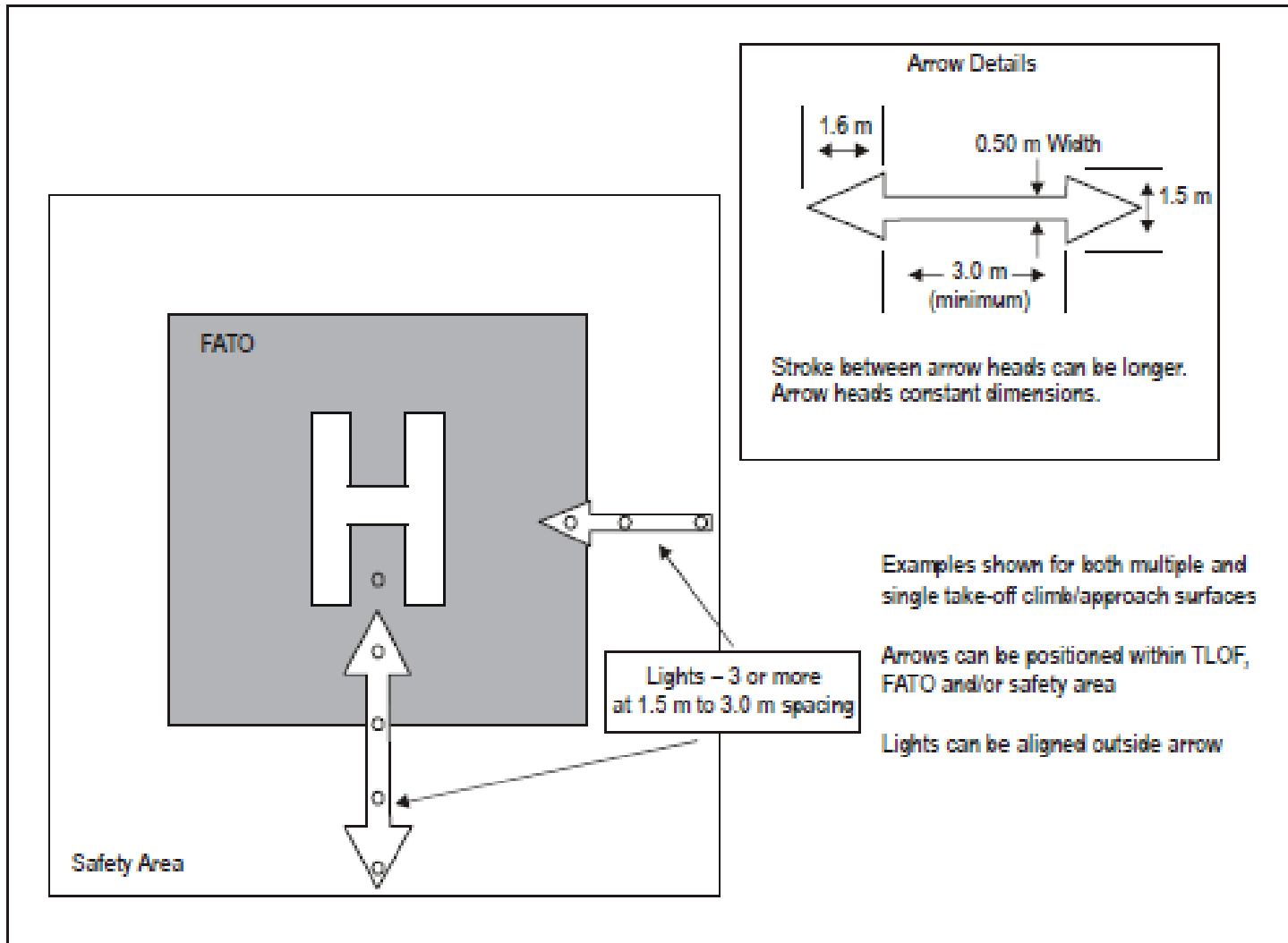
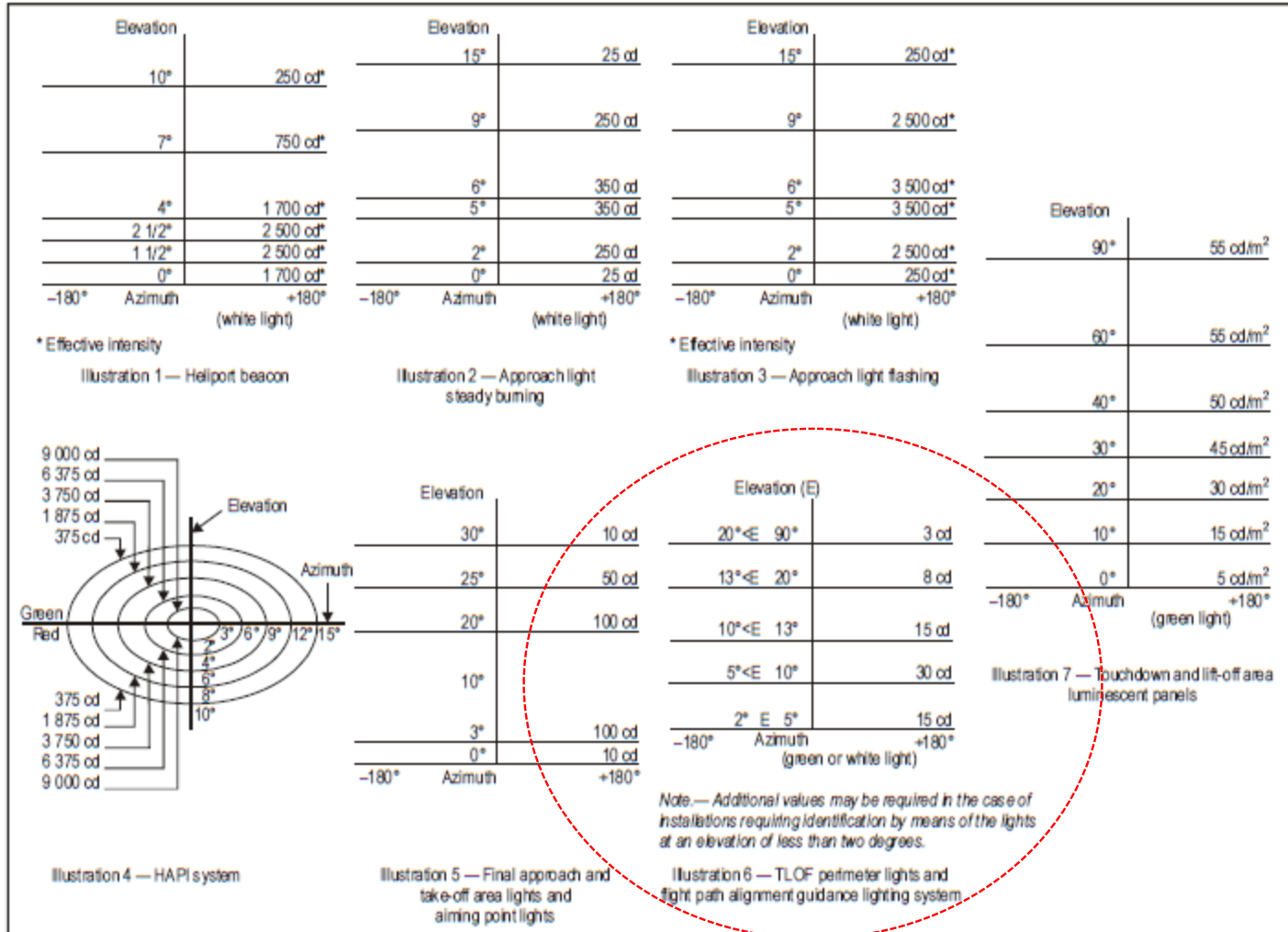

Figure 5-9. Flight path alignment guidance markings and lights

Figure 5-11. Isocandela diagrams







Visual Alignment Guidance System

A visual alignment guidance system should be provided to serve the approach to a heliport where one or more of the following conditions exist especially at night:

- a) obstacle clearance, noise abatement or traffic control procedures require a particular direction to be flown;*
- b) the environment of the heliport provides few visual surface cues; and*
- c) it is physically impracticable to install an approach lighting system.*

The visual alignment guidance system shall be located such that a helicopter is guided along the prescribed track towards the FATO.

The system should be located at the downwind edge of the FATO and aligned along the preferred approach direction.

- Shall be frangible and mounted as low as possible.
- Light units shall be located such that at the extremes of system coverage the angle subtended between units as seen by the pilot shall not be less than 3 minutes of arc.
- Signal format of the alignment guidance system shall include a minimum of three discrete signal sectors providing “offset to the right”, “on track” and “offset to the left” signals.
- The divergence of the “on track” sector of the system shall be as shown in Figure 5-13.
- Signal format shall be such that there is no possibility of confusion between the system and any associated VASI.
- The signal format shall be such that the system is unique and conspicuous in all operational environments.
- The system shall not significantly increase the pilot workload.

Visual Alignment Guidance System

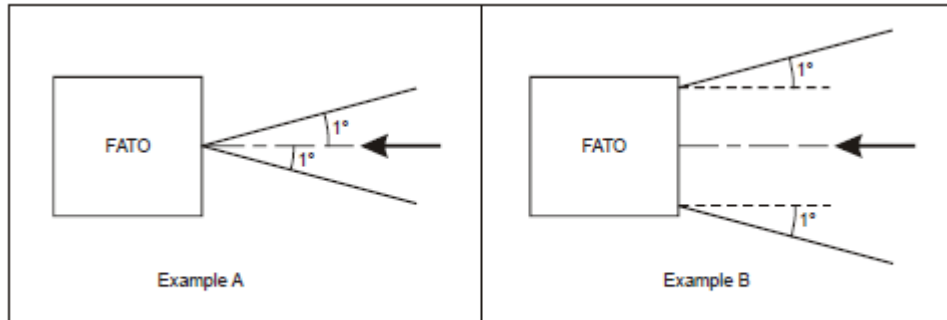

Figure 5-13. Divergence of the “on track” sector



Approach Azimuth Guidance
 The SAGA (System of Azimuth Guidance for Approach) provides a combined signal of approach azimuth guidance and threshold identification

Table 5-1. Dimensions and slopes of the obstacle protection surface

SURFACE AND DIMENSIONS	FATO	
Length of inner edge	Width of safety area	
Distance from end of FATO	3 m minimum	
Divergence	10%	
Total length	2 500 m	
Slope	PAPI	$A^a - 0.57^\circ$
	HAPI	$A^b - 0.65^\circ$
	APAPI	$A^a - 0.9^\circ$
<p>a. As indicated in Annex 14, Volume I, Figure 5-19. b. The angle of the upper boundary of the "below slope" signal.</p>		

3 degree PAPI – lower limit 2 deg 30 sec
 3 degree APAPI Lower limit 2 deg 45 sec

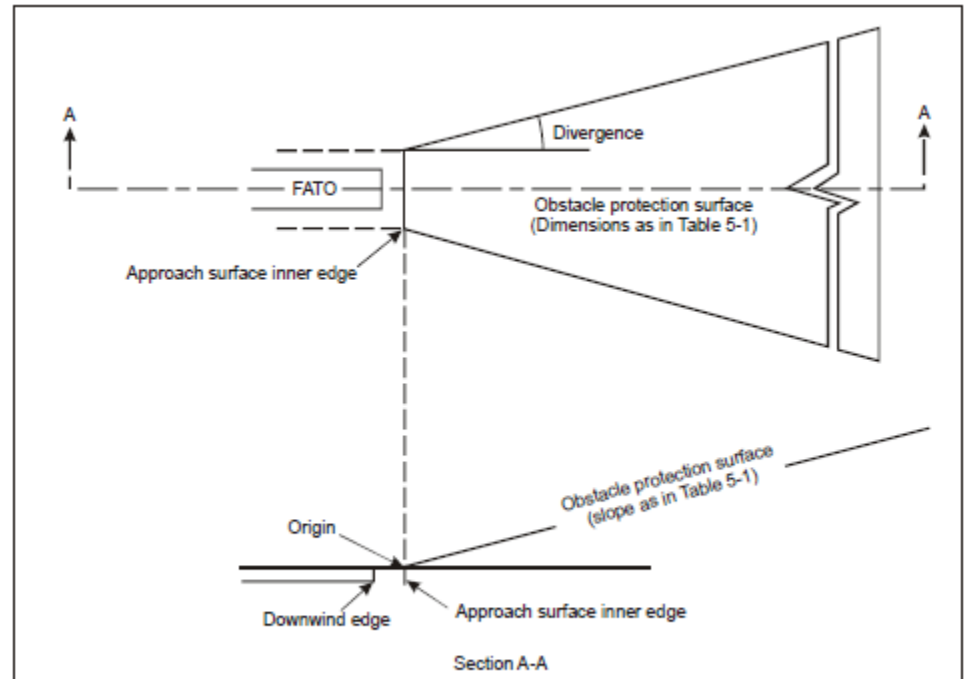

Figure 5-14. Obstacle protection surface for visual approach slope indicator systems

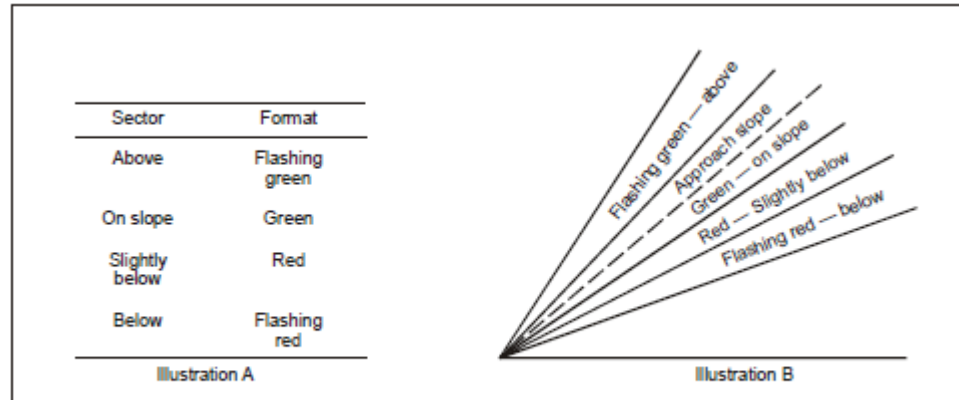
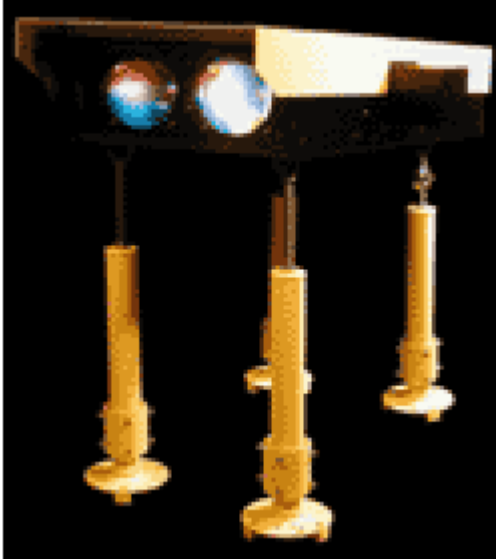

Figure 5-15. HAPI signal format

HAPI: Visual Approach Slope Indicator For Heliports

Aiming Point Lights

Where an aiming point marking is provided at a heliport intended for use at night, aiming point lights should be provided.

Aiming point lights shall be collocated with the aiming point marking.

Aiming point lights shall form a pattern of at least six omnidirectional white lights as shown in Figure 5-6. The lights shall be inset when a light extending above the surface could endanger helicopter operations.

The light distribution of aiming point lights should be as shown in Figure 5-11, Illustration 5.

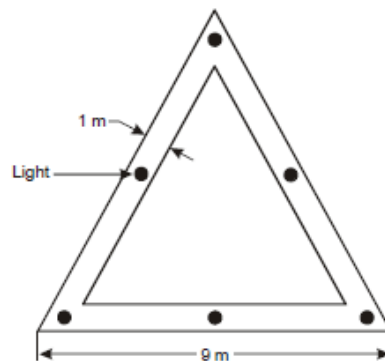
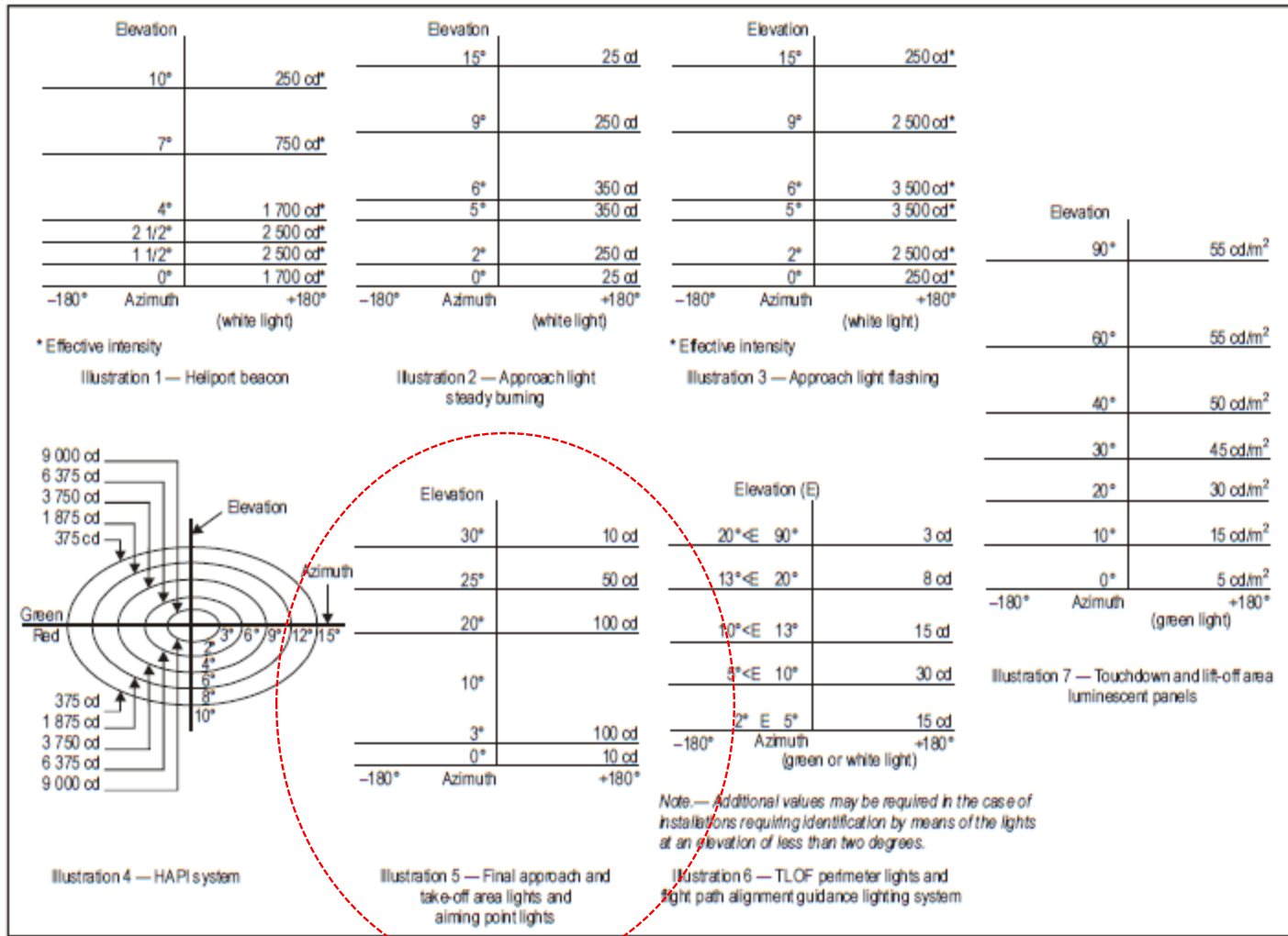

Figure 5-11. Isocandela diagrams





FATO Light Systems for Surface Level Heliports

Where a FATO is established at a surface-level heliport on ground intended for use at night, FATO lights shall be provided except that they may be omitted where the FATO and the TLOF are nearly coincidental or the extent of the FATO is self-evident.

FATO lights shall be placed along the edges of the FATO. The lights shall be uniformly spaced as follows:

- a) for an area in the form of a square or rectangle, at intervals of not more than 50 m with a minimum of four lights on each side including a light at each corner; and
- b) for any other shaped area, including a circular area, at intervals of not more than 5 m with a minimum of ten lights.

FATO lights shall be fixed omnidirectional lights showing white **[or green]**. Where the intensity of the lights is to be varied the lights shall show variable white **[or green]**.

The light distribution of FATO lights should be as shown in Figure 5-11, Illustration 5. **[This illustration should be showing white or green similar to illustration 6].**

The lights should not exceed a height of 25 cm and should be inset when a light extending above the surface would endanger helicopter operations. Where a FATO is not meant for lift-off or touchdown, the lights should not exceed a height of 25 cm above ground or snow level.

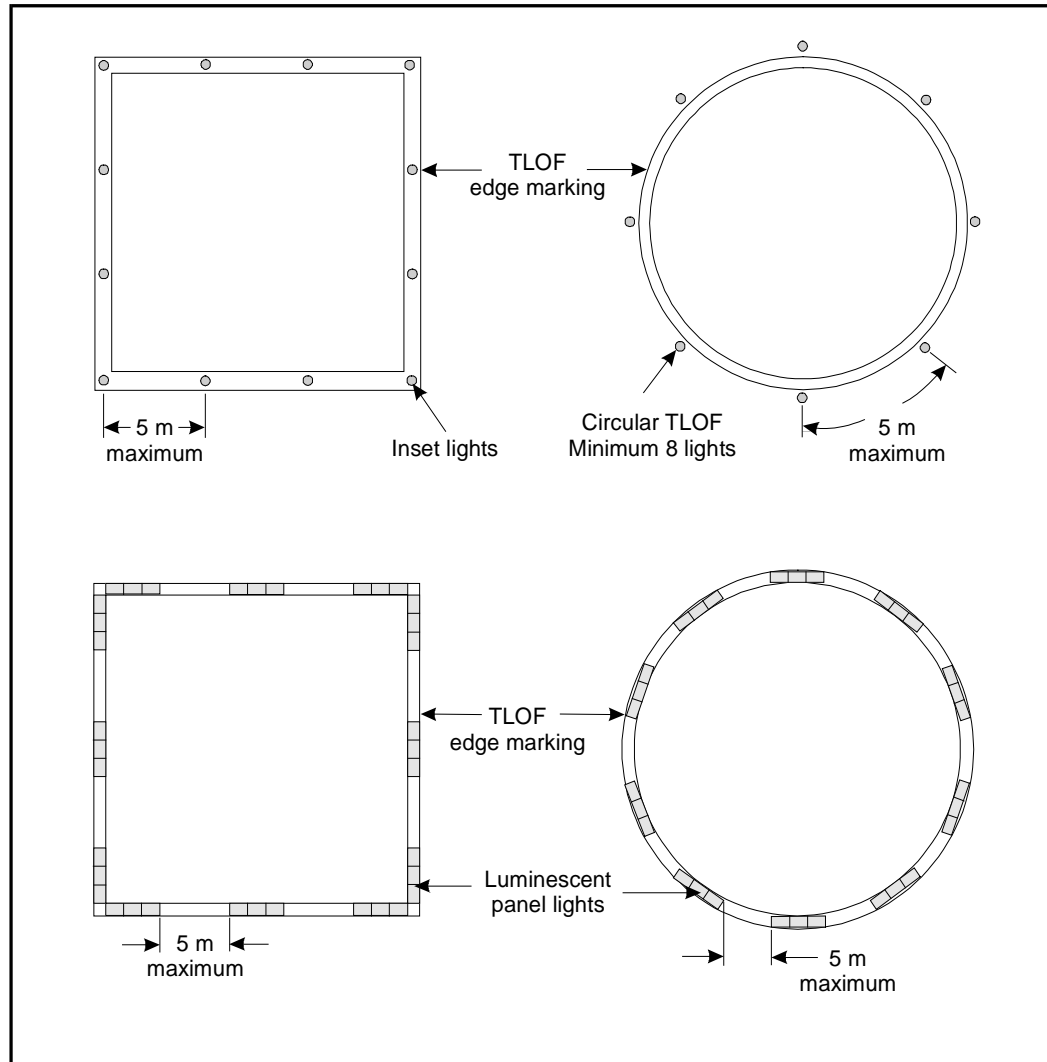

Figure 5-16. Examples of TLOF lighting







Figure 5-11. Isocandela diagrams

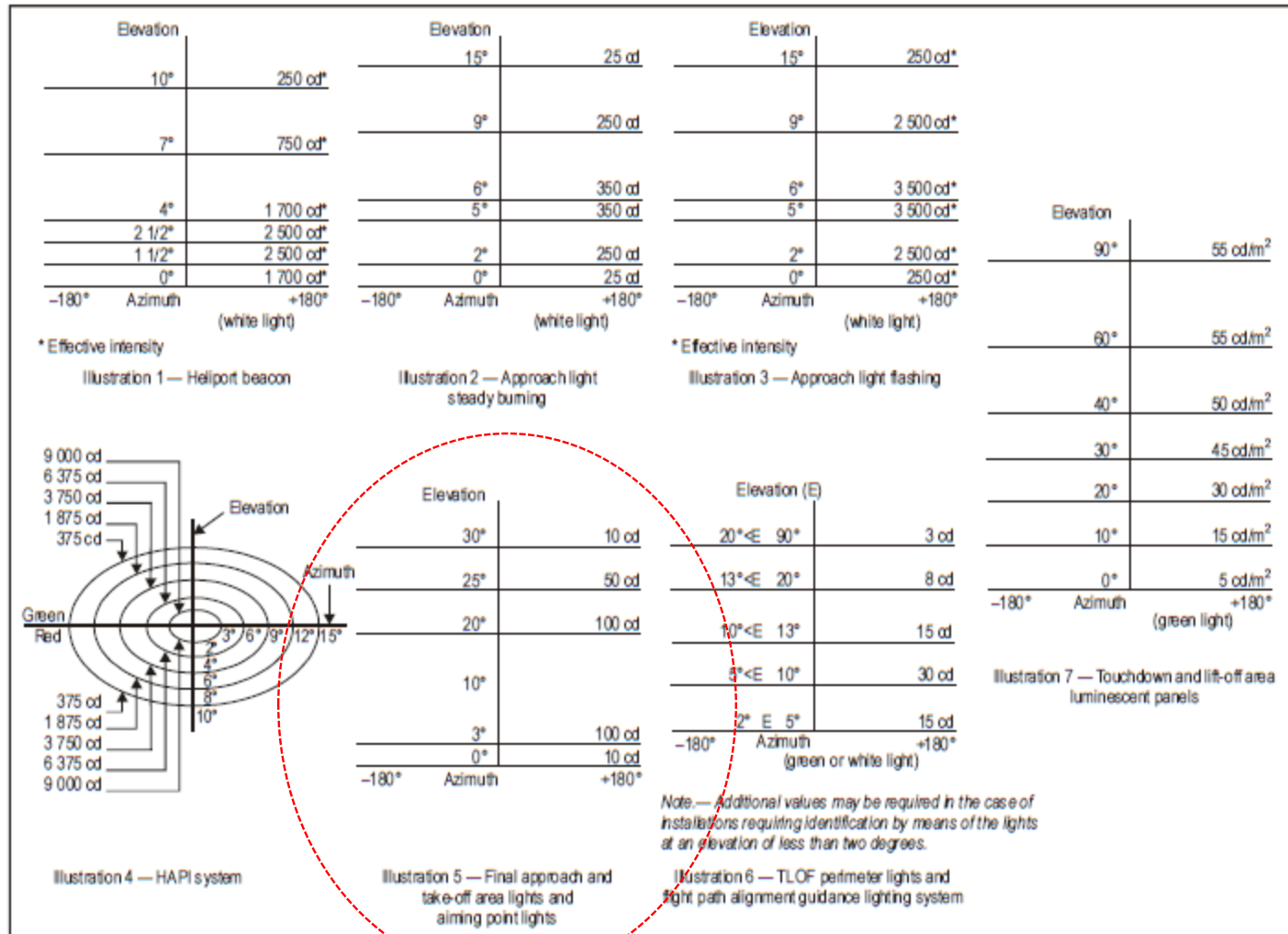



TLOF Lighting System Surface Level & Elevated Heliports where FATO/TLOF are Coincidental

A TLOF lighting system shall be provided at a heliport intended for use at night.

The TLOF lighting system for a surface-level heliport shall consist of one or more of the following:

- a) perimeter lights; or
- b) floodlighting; or
- c) arrays of segmented point source lighting (ASPSL) or luminescent panel (LP) lighting to identify the TLOF when a) and b) are not practicable and FATO lights are available.

The TLOF lighting system for an elevated heliport or helideck shall consist of:

- a) perimeter lights; and
- b) ASPSL and/or LPs to identify the touchdown marking where it is provided and/or floodlighting to illuminate the TLOF.

At elevated heliports and helidecks, surface texture cues within the TLOF are essential for helicopter positioning during the final approach and landing. Such cues can be provided using various forms of lighting (ASPSL, LP, floodlights or a combination of these lights, etc.) in addition to perimeter lights. Best results have been demonstrated by the combination of perimeter lights and ASPSL in the form of encapsulated strips of light emitting diodes (LEDs) to identify the touchdown and heliport identification markings.

TLOF ASPSL and/or LPs to identify the touchdown marking and/ or floodlighting should be provided at a surface-level heliport intended for use at night when enhanced surface texture cues are required.



TLOF perimeter lights shall be placed along the edge of the area designated for use as the TLOF or within a distance of 1.5 m from the edge. Where the TLOF is a circle the lights shall be:

- a) located on straight lines in a pattern which will provide information to pilots on drift displacement; and
- b) where a) is not practicable, evenly spaced around the perimeter of the TLOF at the appropriate interval, except that over a sector of 45 degrees the lights shall be spaced at half spacing.

TLOF perimeter lights shall be uniformly spaced at intervals of not more than 3 m for elevated heliports and helidecks and not more than 5 m for surface-level heliports. There shall be a minimum number of four lights on each side including a light at each corner. For a circular TLOF, where lights are installed in accordance with 5.3.9.5 b) there shall be a minimum of fourteen lights.

The TLOF perimeter lights shall be installed at an elevated heliport or fixed helideck such that the pattern cannot be seen by the pilot from below the elevation of the TLOF.

The TLOF perimeter lights shall be installed at a floating helideck, such that the pattern cannot be seen by the pilot from below the elevation of the TLOF when the helideck is level.

On surface-level heliports, ASPSL or LPs, if provided to identify the TLOF, shall be placed along the marking designating the edge of the TLOF. Where the TLOF is a circle, they shall be located on straight lines circumscribing the area.

On surface-level heliports the minimum number of LPs on a TLOF shall be nine. The total length of LPs in a pattern shall not be less than 50 per cent of the length of the pattern. There shall be an odd number with a minimum number of three panels on each side of the TLOF including a panel at each corner. LPs shall be uniformly spaced with a distance between adjacent panel ends of not more than 5 m on each side of the TLOF.

When LPs are used on an elevated heliport or helideck to enhance surface texture cues, the panels should not be placed adjacent to the perimeter lights. They should be placed around a touchdown marking where it is provided or coincident with heliport identification marking.

TLOF floodlights shall be located so as to avoid glare to pilots in flight or to personnel working on the area. The arrangement and aiming of floodlights shall be such that shadows are kept to a minimum.

ASPSL and LPs used to designate the touchdown and/or heliport identification marking have been shown to provide enhanced surface texture cues when compared to low-level floodlights. Due to the risk of misalignment, if floodlights are used, there will be a need for them to be checked periodically to ensure they remain within the specifications contained within 5.3.9.

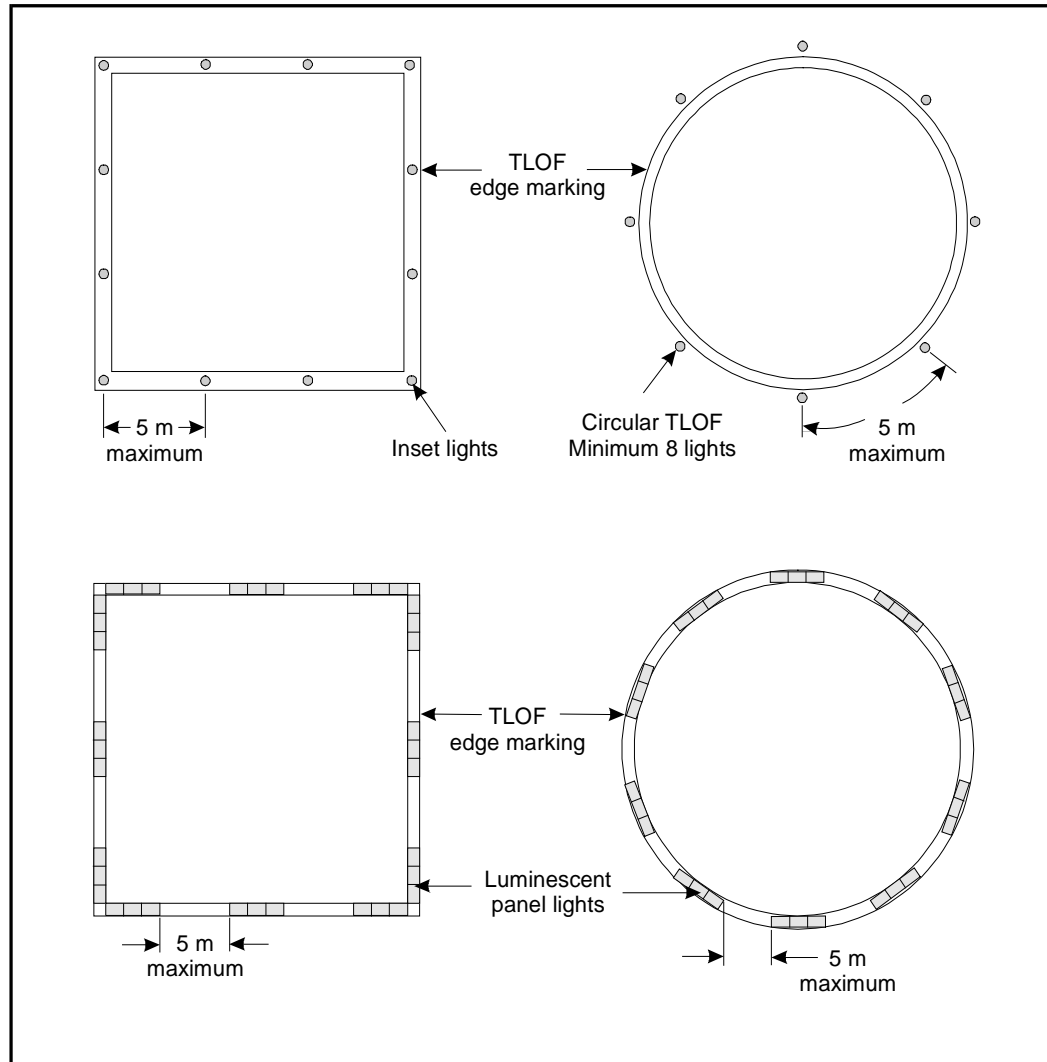

Figure 5-16. Examples of TLOF lighting



The TLOF perimeter lights shall be fixed omnidirectional lights showing green.

At a surface-level heliport, ASPSL or LPs shall emit green light when used to define the perimeter of the TLOF.

The chromaticity and luminance of colours of LPs should conform to Annex 14, Volume I, Appendix 1, 3.4.

An LP shall have a minimum width of 6 cm. The panel housing shall be the same colour as the marking it defines.

The perimeter lights should not exceed a height of 25 cm and should be inset when a light extending above the surface could endanger helicopter operations.

When located within the safety area of a heliport or within the obstacle-free sector of a helideck, the TLOF floodlights should not exceed a height of 25 cm.

The LPs shall not extend above the surface by more than 2.5 cm.

The light distribution of the perimeter lights should be as shown in Figure 5-11, Illustration 6.

The light distribution of the LPs should be as shown in Figure 5-11, Illustration 7.

The spectral distribution of TLOF area floodlights shall be such that the surface and obstacle marking can be correctly identified. Recommendation.— The average horizontal illuminance of the floodlighting should be at least 10 lux, with a uniformity ratio (average to minimum) of not more than 8:1 measured on the surface of the TLOF.

Lighting used to identify the touchdown marking should comprise a segmented circle of omnidirectional ASPSL strips showing yellow. The segments should consist of ASPSL strips, and the total length of the ASPSL strips should not be less than 50 per cent of the circumference of the circle.

If utilized, the heliport identification marking lighting should be omnidirectional showing green.

Figure 5-11. Isocandela diagrams

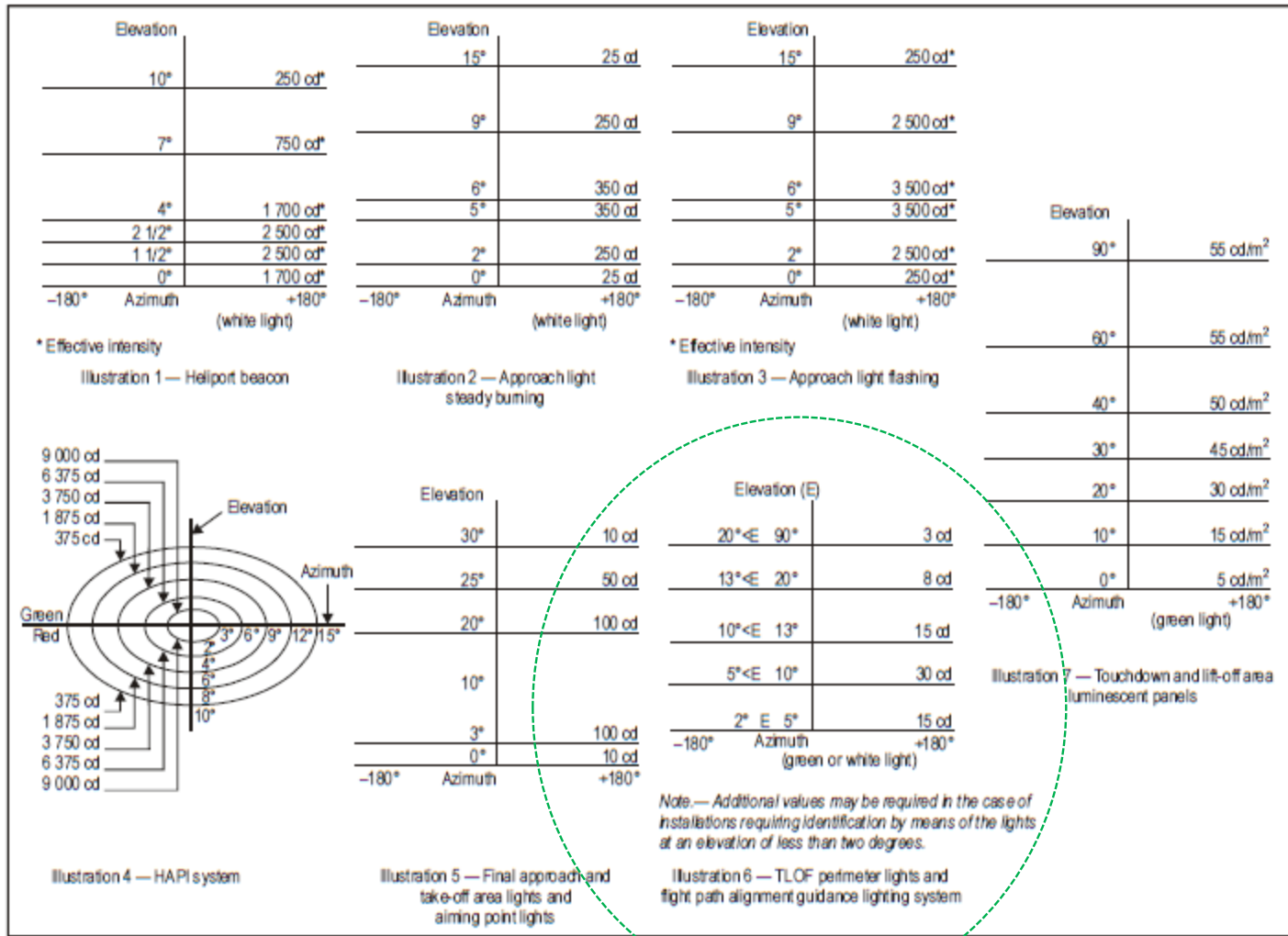
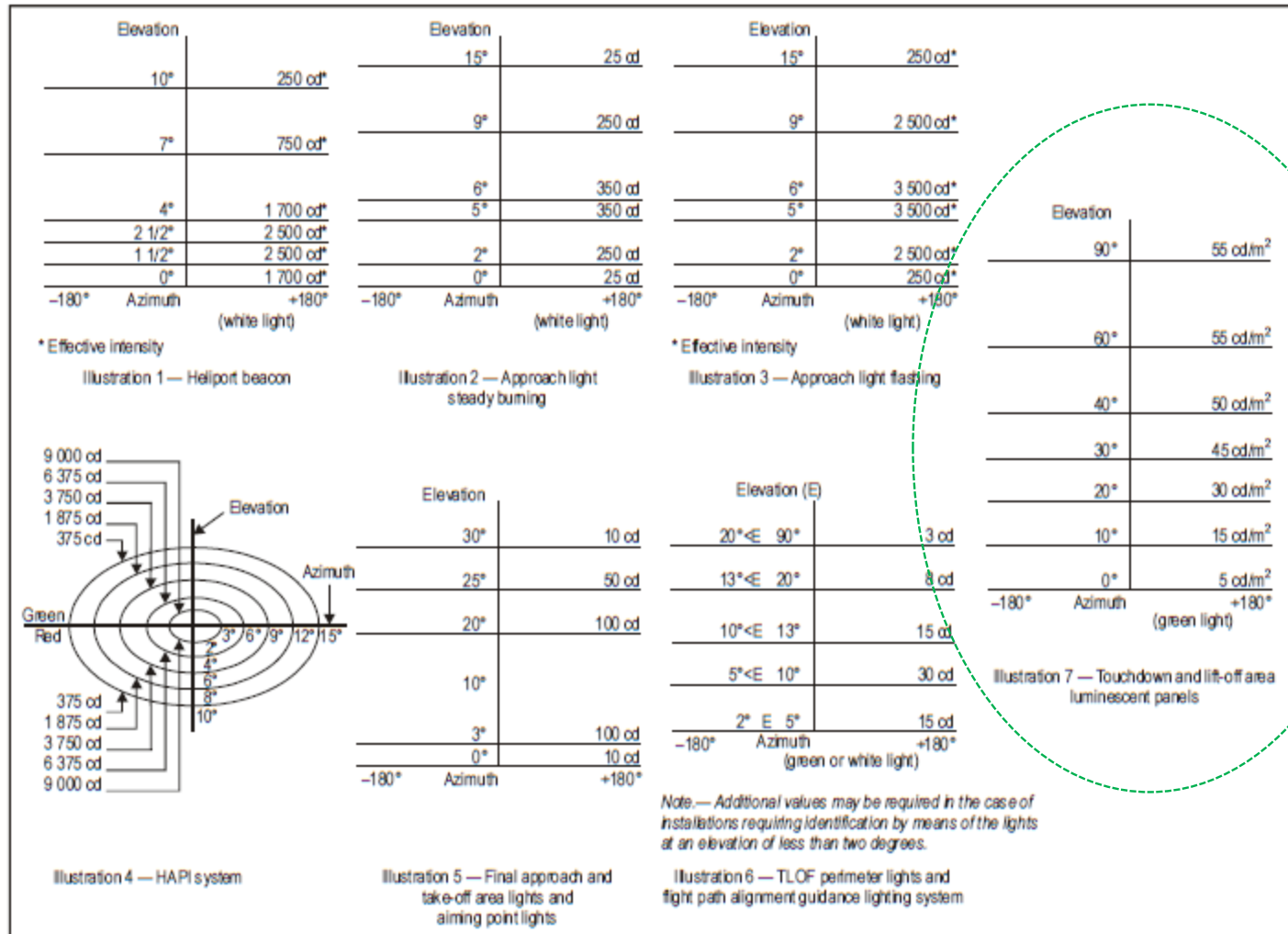
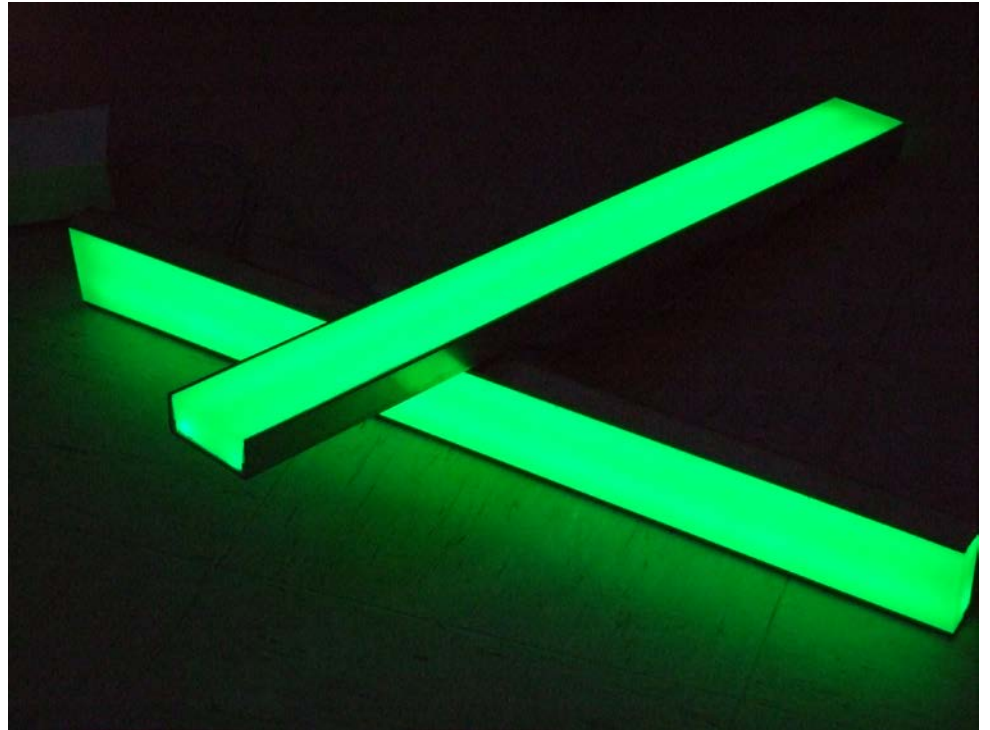

Figure 5-11. Isocandela diagrams











Flinders FCIC



Kiln-Merhiem Hospital



Stockholm Hospital











Questions?



Baillie & Associates

International Aviation Regulations & Standards Development

Christopher J. F. Baillie
Managing Director

Ottawa, Ontario, Canada

chrisbaillie@storm.ca

